

# Wire Suspension - Installation Instruction

Item	Title
1	Ferrule
2	Suspension Wire, single, split, or twin
3	Barrel
4	Suspension Channel
5	Extrusion
6	End Plate (with or without screws)
7	Ceiling
8	Beam or Support
9	Screw/Fixture

**Notes:**

1. Tightening grub screw onto stainless steel wire causes deformation to wire. If re-adjustment is required a new cable must be used. Unless a shorter wire

2. Remove non-permanent labelling and tapes as you proceed as you proceed

3. It is the installers responsibility to ensure that the ceiling is strong enough to support the weight of the fitting.

4. Where a luminaire has a flex and no plug, we recommend using a clipsal 240/20 series or similar junction box at the point of termination.

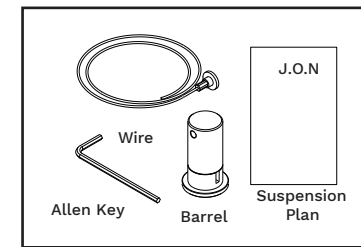
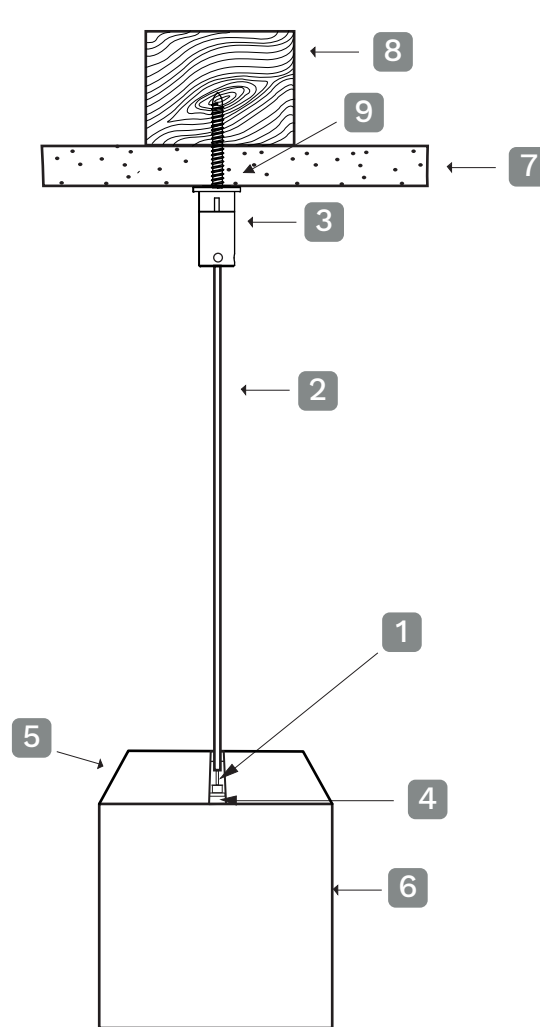
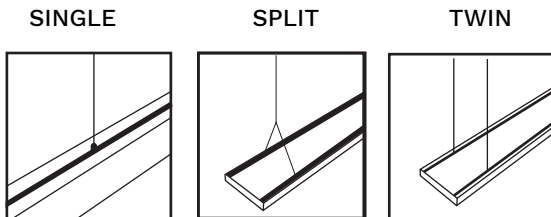

Identify suspension items

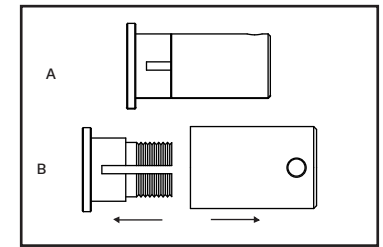

Unscrew separate barrel parts

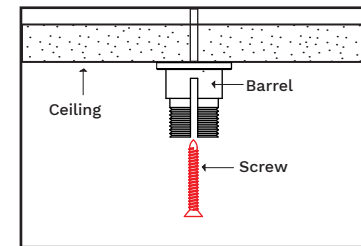

Slide screw into the barrel with screw driver

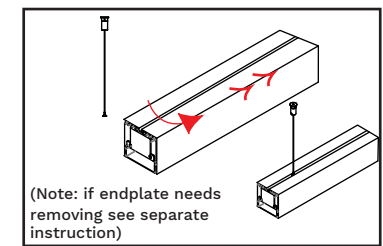

Slide ferrule into suspension track

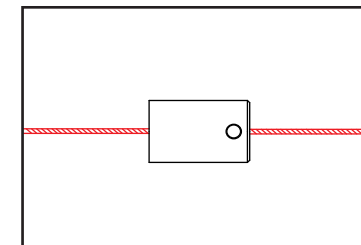

Insert wire into barrel cap

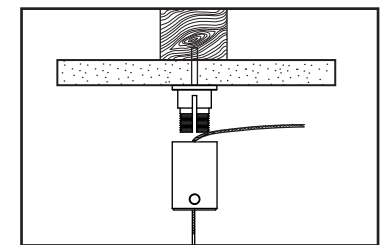

Screw cap onto fixed base. Ensure end of cable protrudes through slot of base

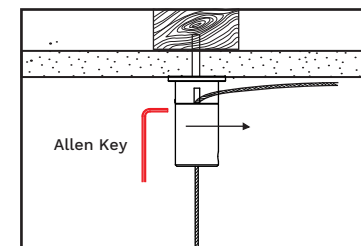

Adjust height and level fitting then tighten grub screws with the Allen key provided

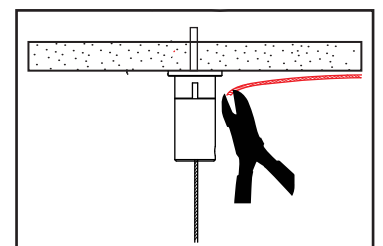

Cut off excess cable with wire cutters