

# Recessed - Installation Instruction

Item	Title
1	Screw
2	Ceiling
3	Gyprock clip
4	Diffuser
5	Luminaire

Notes: The installer is responsible for ensuring that the ceiling is strong enough to support the luminaire.

Where a luminaire has a flex and no plug, we recommend using a clipsal 240/20 series or similar junction box at the point of termination.

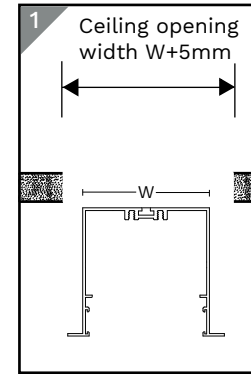
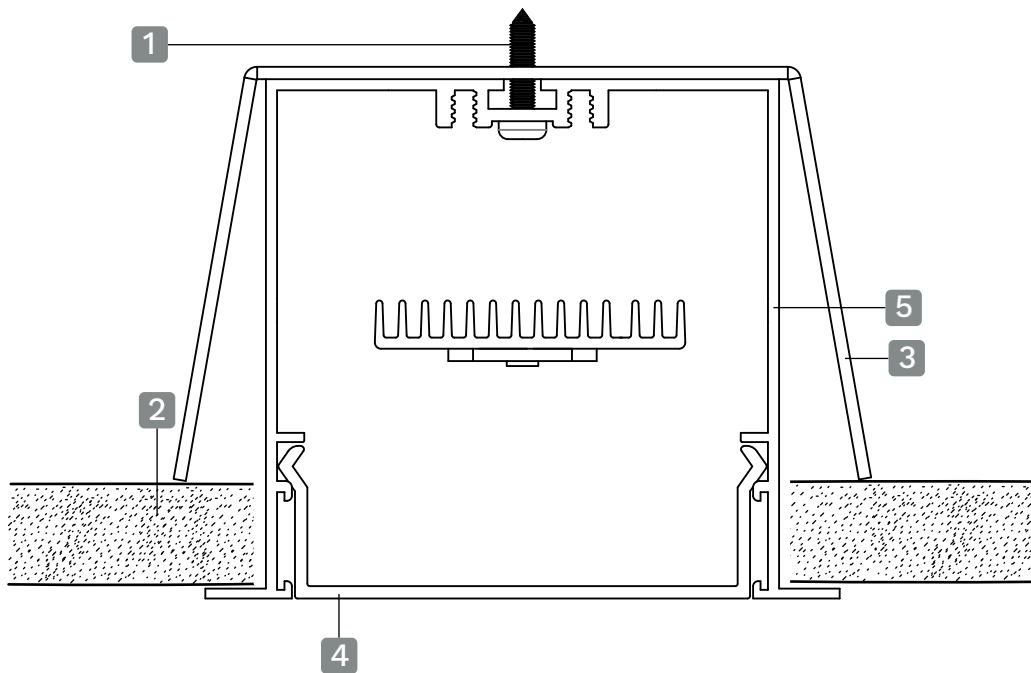

Ensure ceiling cut out is the correct width

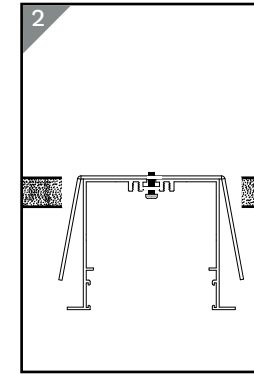

Place gyprock bracket in position with screw at maximum extension

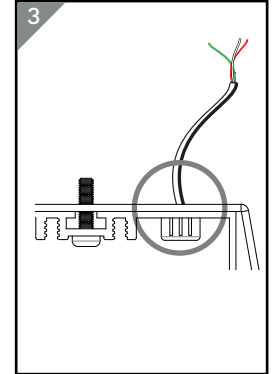

Make sure power is connected in ceiling while being placed into position

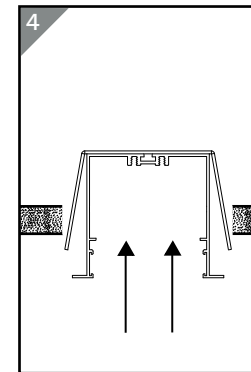

While unit is being lifted into place ensure brackets can squeeze into ceiling cut out

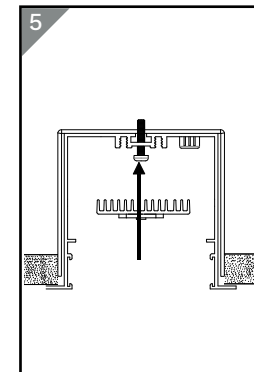

Push screws in fully once unit is in place. Ensure gyprock bracket legs secure unit into ceiling

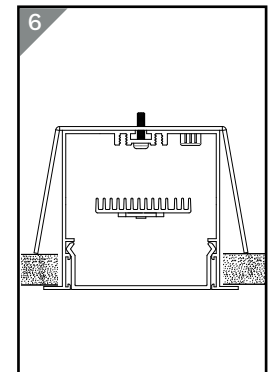

Tighten screw (s) ensuring brackets are kept parallel and even.

Note: Do Not Over Tighten Screws